

BEAM PENTODE

DESCRIPTION AND RATING

The 6BK5 is a miniature beam pentode designed primarily for use in the audio-frequency power output stage of television and radio receivers in which only small driving voltages are available. Features of the tube include extremely high power sensitivity, high transconductance, and high plate efficiency.

Except for heater ratings and heater-cathode voltage ratings, the 12BK5 is identical to the 6BK5. The 12BK5, as a result of its controlled heater warm-up characteristic, is especially suited for use in television receivers which employ series-connected heaters. When the 12BK5 is used in conjunction with other 600-milliamper types which exhibit essentially the same heater warm-up characteristic, heater voltage surges across the individual tubes are minimized during the warm-up period.

The 25BK5 differs from the 6BK5 only in heater ratings.

GENERAL

ELECTRICAL

	6BK5	12BK5	25BK5
Cathode—Coated Unipotential			
Heater Voltage, AC or DC	6.3	12.6	25.0 Volts
Heater Current	1.2	0.6	0.3 Amperes
Heater Warm-up Time*	...	11	... Seconds
Direct Interelectrode Capacitances†			
Grid-Number 1 to Plate			0.6 μf
Input			13 μf
Output			5.0 μf

MECHANICAL

Mounting Position—Any
Envelope—T-6½, Glass
Base—E9-1, Small Button 9-Pin

MAXIMUM RATINGS

DESIGN-CENTER VALUES

Plate Voltage		250	Volts
Screen Voltage		250	Volts
Positive DC Grid-Number 1 Voltage		0	Volts
Plate Dissipation		9.0	Watts
Screen Dissipation		2.5	Watts
Heater-Cathode Voltage	12BK5	6BK5, 25BK5	
Heater Positive with Respect to Cathode			
DC Component	100	Volts
Total DC and Peak	200	100	Volts
Heater Negative with Respect to Cathode			
Total DC and Peak	200	100	Volts
Grid-Number 1 Circuit Resistance			
With Fixed Bias	0.1	0.1	Megohms
With Cathode Bias	0.5	0.5	Megohms

BASING DIAGRAM

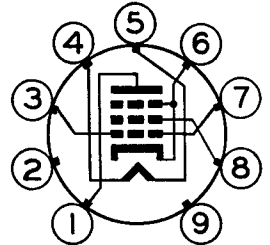

RETMA 9BQ

TERMINAL CONNECTIONS

- Pin 1—Plate
- Pin 2—No Connection
- Pin 3—Grid Number 1
- Pin 4—Heater
- Pin 5—Heater
- Pin 6—Cathode and Beam Plates
- Pin 7—Grid Number 1
- Pin 8—Grid Number 2 (Screen)
- Pin 9—No Connection

PHYSICAL DIMENSIONS

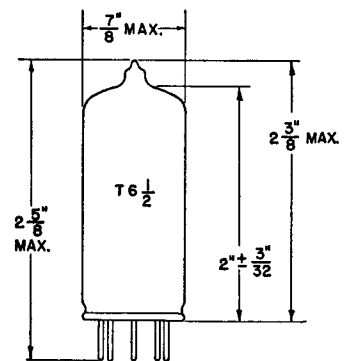

RETMA 6-3

CHARACTERISTICS AND TYPICAL OPERATION

CLASS A₁ AMPLIFIER

Plate Voltage	250	Volts
Screen Voltage	250	Volts
Grid-Number 1 Voltage	-5.0	Volts
Peak AF Grid-Number 1 Voltage	5.0	Volts
Plate Resistance, approximate	100000	Ohms
Transconductance	8500	Micromhos
Zero-Signal Plate Current	35	Milliamperes
Maximum-Signal Plate Current, approximate	37	Milliamperes
Zero-Signal Screen Current	3.5	Milliamperes
Maximum-Signal Screen Current, approximate	10	Milliamperes
Load Resistance	6500	Ohms
Total Harmonic Distortion, approximate	7	Percent
Maximum-Signal Power Output	3.5	Watts

* Heater warm-up time is defined as the time required in the circuit shown at the right for the voltage across the heater terminals to increase from zero to the heater test voltage (V_1). For this type, $E=50$ volts (RMS or DC), $V_1=10.0$ volts (RMS or DC), and $R=63$ ohms.
 † Without external shield.

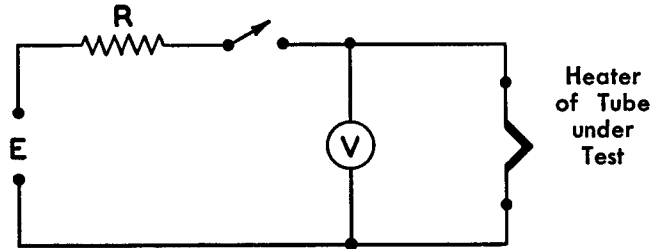

AVERAGE PLATE CHARACTERISTICS

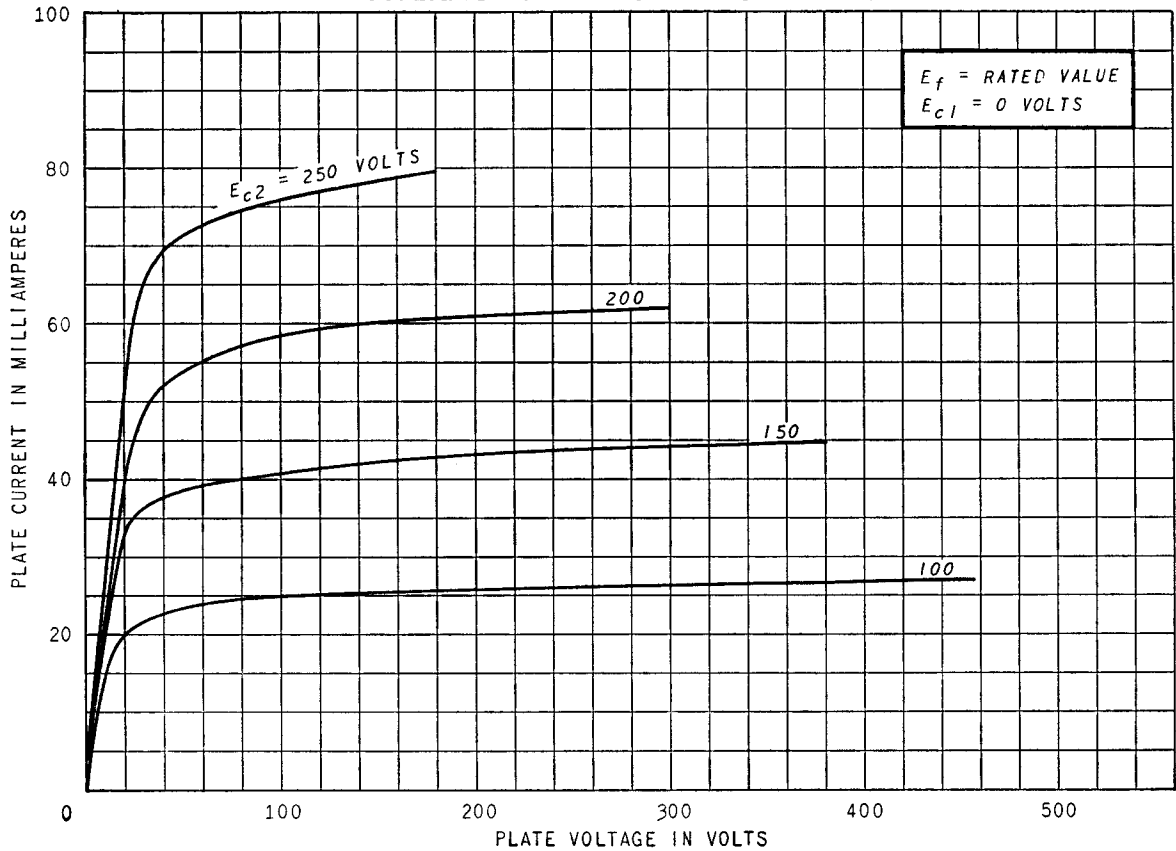

AVERAGE PLATE CHARACTERISTICS

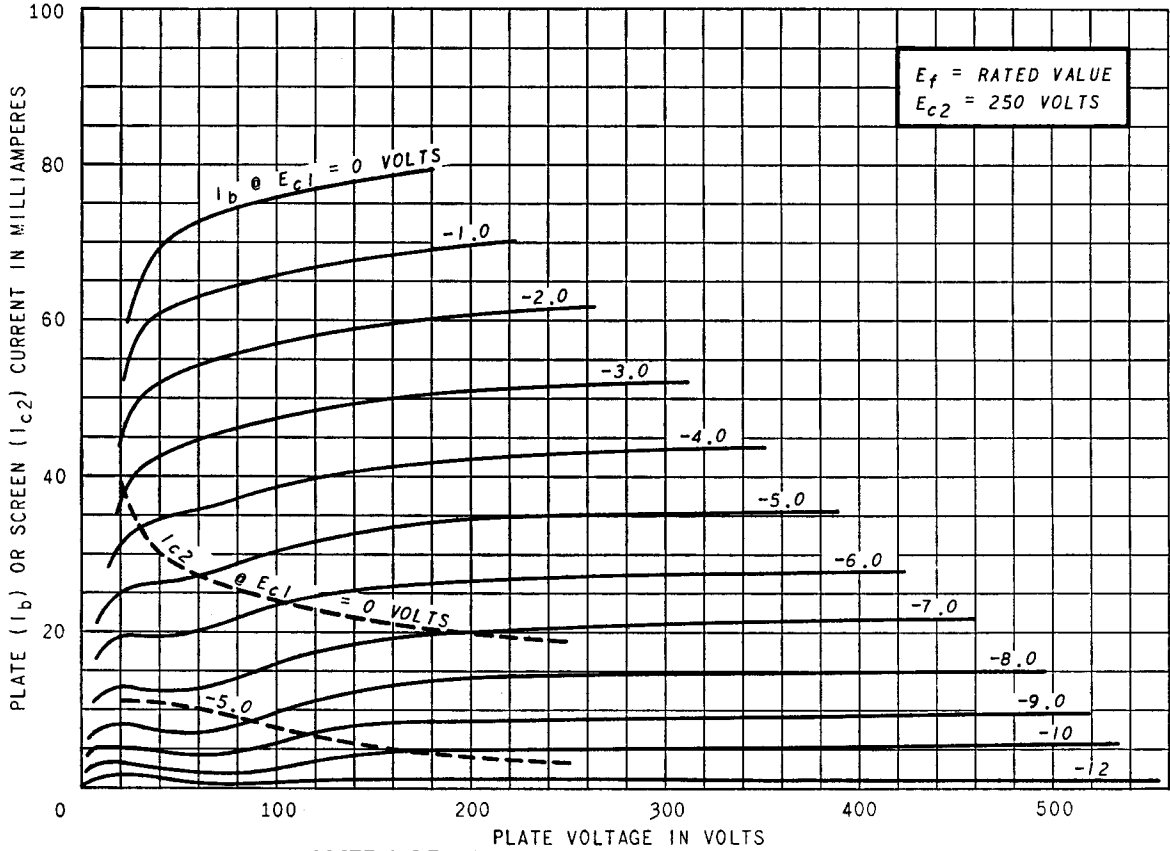

AVERAGE TRANSFER CHARACTERISTICS

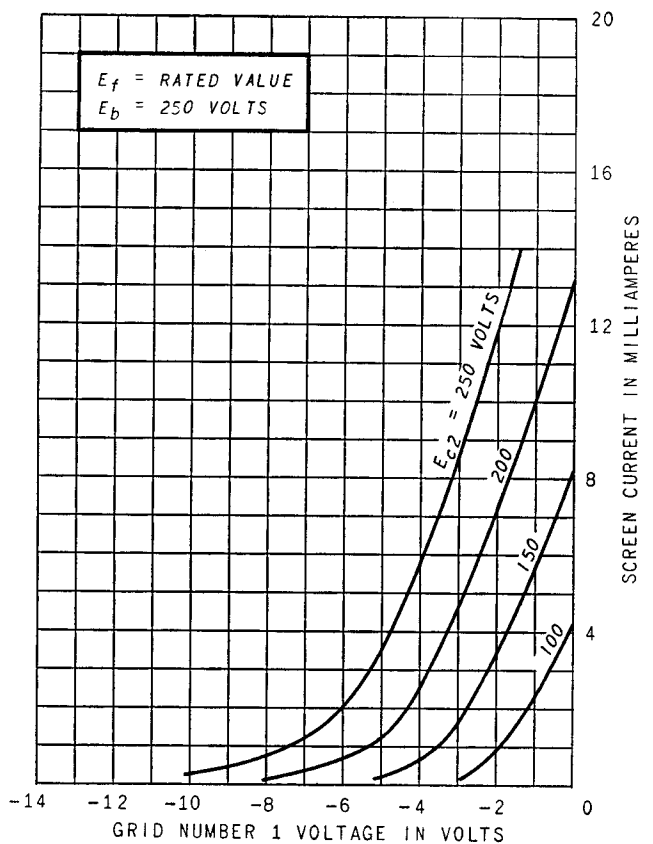
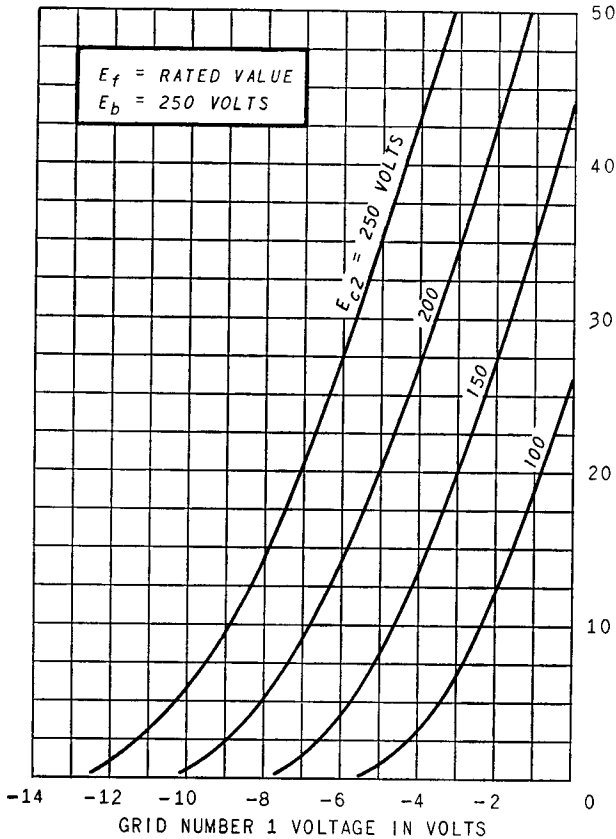

OPERATION CHARACTERISTICS

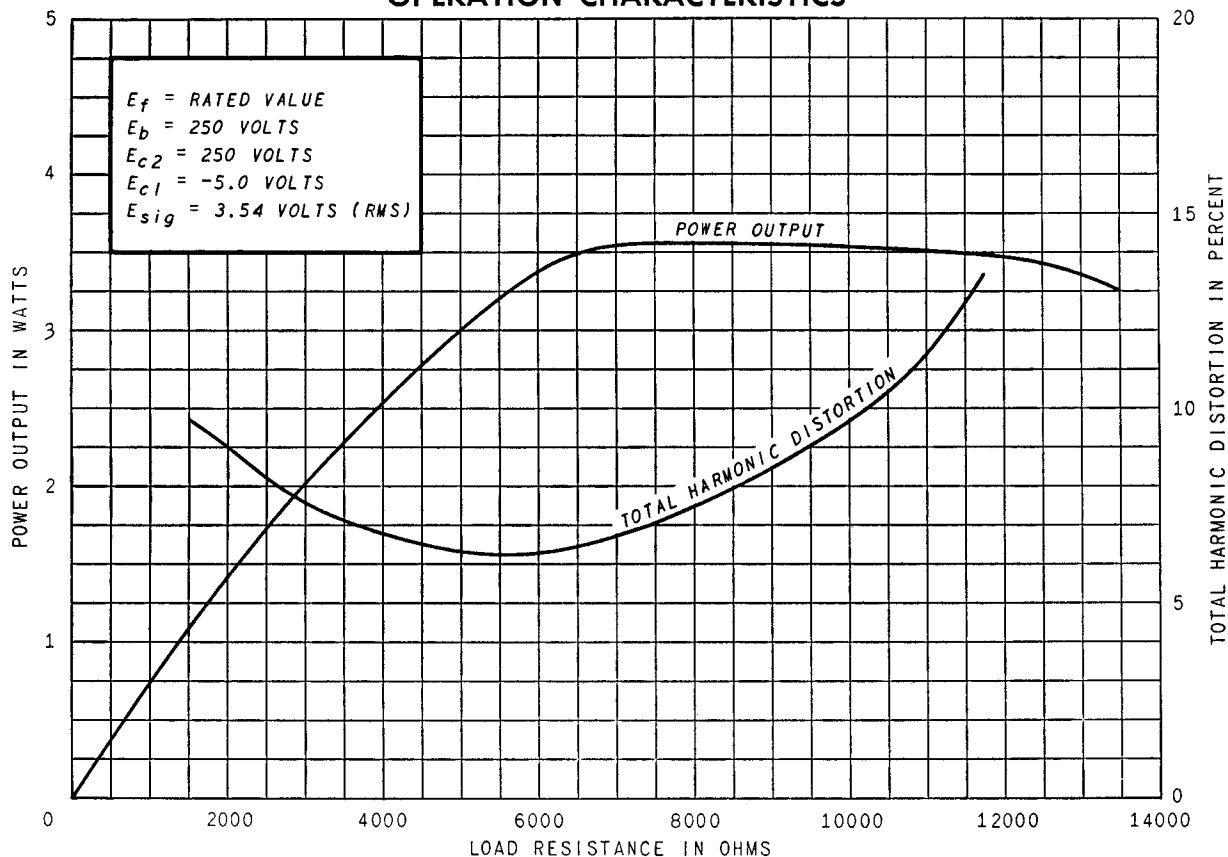

TUBE DEPARTMENT



Schenectady 5, N. Y.